

# AdvanFitting-300™

## Interactive system for fitting rooms

Watch a video of AdvanFitting on [Youtube](#)

### Product overview

AdvanFitting is an RFID-based interactive system for **fitting rooms** at retail stores.

AdvanFitting uses **RFID** technology and a **touch screen** to improve the shopping experience of customers at retail stores.

The **process** is as follows:

1. The customer enters the fitting room with items of his interest, to try them on
2. The RFID subsystem of AdvanFitting detects these items automatically
3. The screen of AdvanFitting shows images of the items, together with information like colors and sizes available, composition, price, etc.
4. The customer also receives recommendations of matching products and accessories
5. The customer can interact through the touch screen, request other sizes and colors, browse through other products, etc.
6. When the customer requests another size or color, an employee receives a message in a portable device, and brings the product to the customer

Optionally, AdvanFitting can also be connected to the lighting system of the fitting room to give the user the option of setting the tone of the light through the touch screen, to create different ambiances in the fitting room.

By giving recommendations of matching products, AdvanFitting **increases the sales** of the retailer.

### Product description

AdvanFitting units contain everything needed to work on their own.

They are completely independent from each other, so they don't need to be connected to create a system.

Each fitting room can be equipped with an AdvanFitting unit that will work independently from the other fitting rooms.

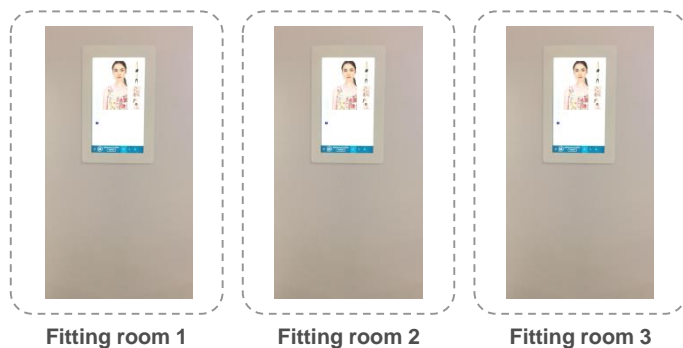

Each fitting room unit comprises:

- RFID subsystem, with one reader and two antennas
- 16'' touch screen
- Embedded computer
- Content and user interface management cloud-based software

For the option of controlling the lighting through AdvanFitting, the fitting room has to be equipped with Philips Hue wireless lighting system.

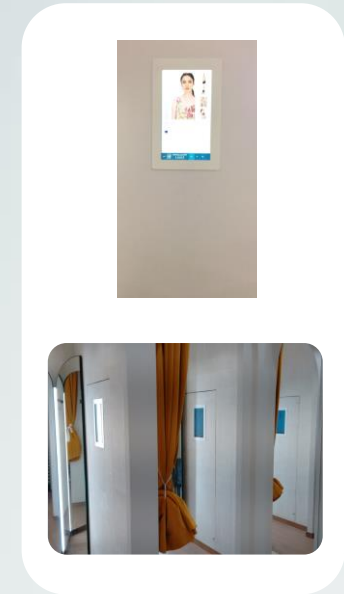

### Benefits:

- Cost-efficient
- Increases sales at retail stores
- Improves the customer shopping experience
- Provides recommendations
- Fun to use
- Generates information about user interests
- The content and user interface can be remotely updated
- Easy connection and installation

### Applications:

- Fitting rooms at retail stores

# AdvanFitting-300™

## Interactive system for fitting rooms



### Product description (cont)

The AdvanFitting unit is installed on the wall of the fitting room. The system is recessed into the wall, so all the electronics are hidden.

The electronics are behind the wall, and the only visible part for shoppers is the screen, and optionally, the frame.

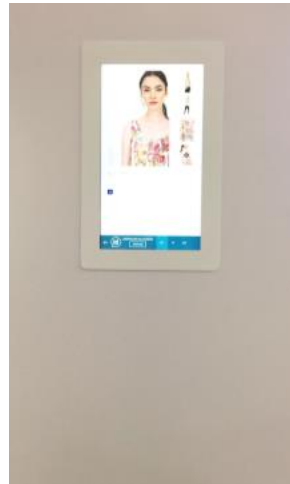
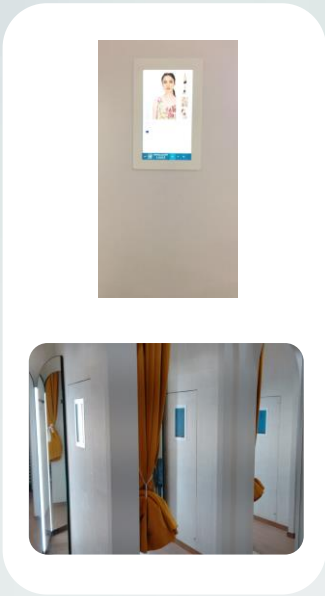

Front view  
Visible



Rear view  
Hidden

By painting the fitting rooms with [AdvanPaint](#), cross-reads are practically eliminated.



(1) to minimize the detection of products of neighboring fitting rooms, some system parameters need to be adjusted, like height of the antenna, transmitted power and sensitivity.

# AdvanFitting-300™

## Interactive system for fitting rooms

### Connection to AdvanCloud

The content and user interface of AdvanFitting can be updated remotely very easily, by means of the **AdvanCloud cloud-based software**.

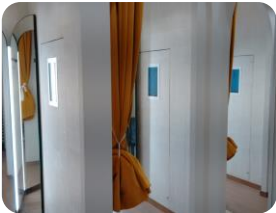

All the events are registered and stored in AdvanCloud. This information can then be analysed for **business intelligence** purposes:

- Number of users that enter the fitting room
- Number of users that interact with the screen
- Products that customers bring inside the fitting room
- Recommended products that customers select on the screen
- Products that the customers request to be brought by an employee
- Etc.

### AdvanCloud servers

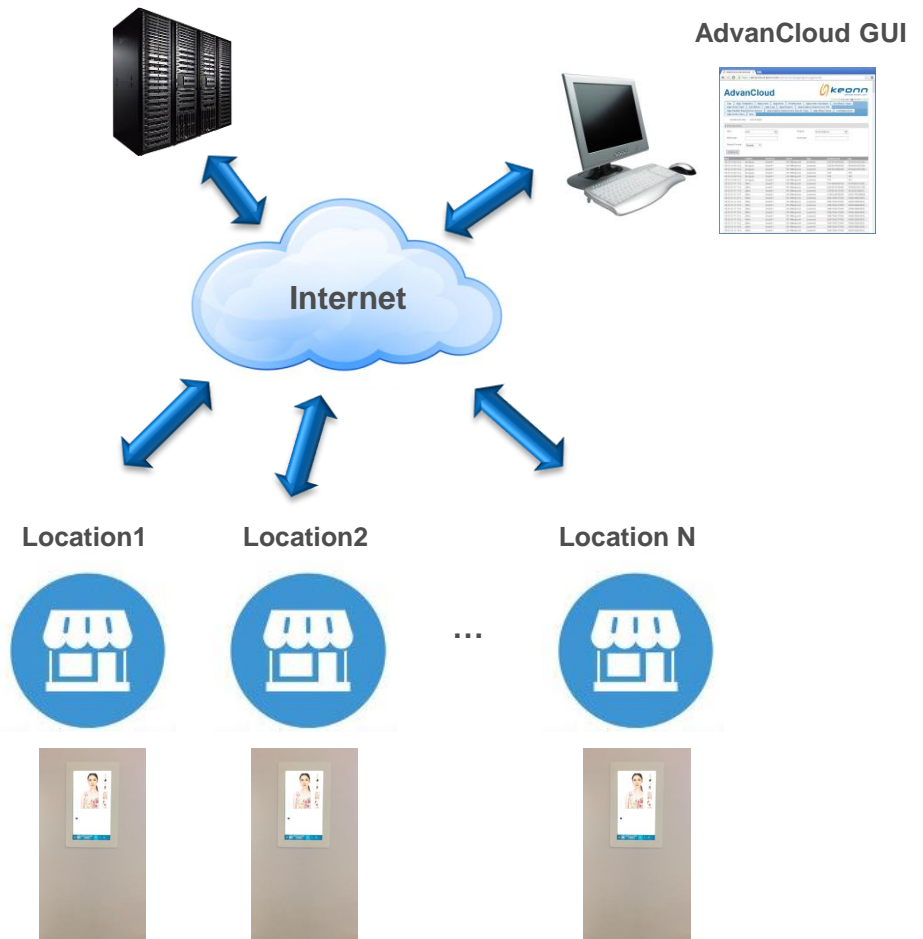

# AdvanFitting-300™

## Interactive system for fitting rooms

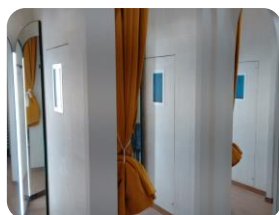

### Technical specifications

Screen size	16 inches
Touch screen technology	Projected Capacitive (10 points)
Operating frequency EU Version	865,6 - 867,6 MHz (ETSI EN 302 208)
Operating frequency US Version	902 - 928 MHz (FCC part 15)
RF Power output	Programmable from 0 dBm to 30 dBm in 0.5 dBm steps. Maximum power may have to be reduced to meet regulatory limits
Standard Compliance	EPC Global UHF Class 1 Gen 2 / ISO 18000-6C
Antenna gain	8.3 dBi (5.3 dBil) EU version
Polarization	Circular
Power	110 V AC - 220 V AC Optional: power over Ethernet
Temperature range	0°C to +40°C
Size of the screen	193 mm x 343 mm x 33 mm 7.59 inches x 13.50 inches x 1.29 inches
Size of the RFID subsystem	1002 mm x 260 mm x 44 mm 39.44 inches x 10.23 inches x 1.73 inches
Weight	6 Kg

### Mechanical specifications: portrait screen orientation

mm [inches]

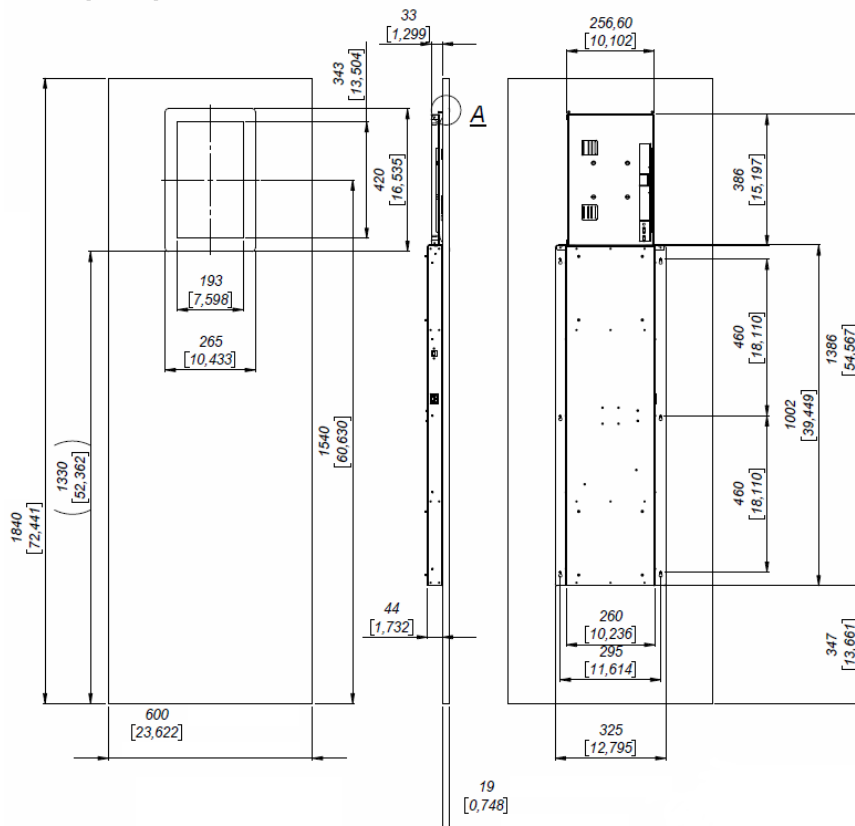

(1) to minimize the detection of products of neighboring fitting rooms, some system parameters need to be adjusted, like height of the antenna, transmitted power and sensitivity.

# AdvanFitting-300™

## Interactive system for fitting rooms



### Mechanical specifications: landscape screen orientation

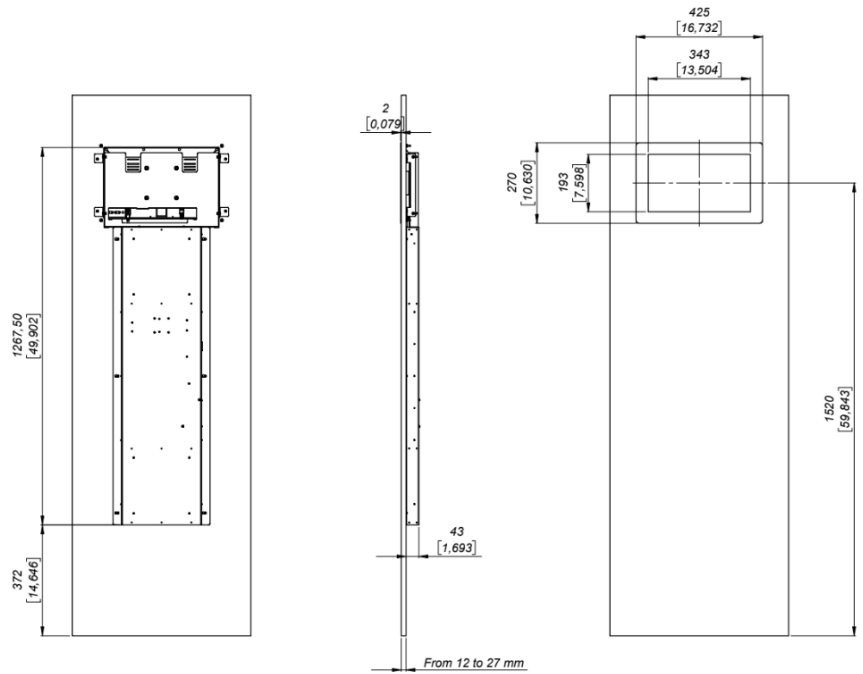
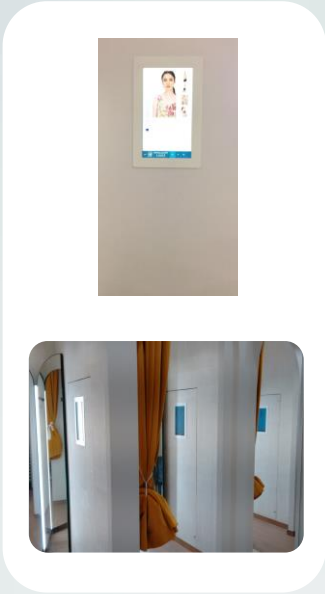

mm [inches]

(1) to minimize the detection of products of neighboring fitting rooms, some system parameters need to be adjusted, like height of the antenna, transmitted power and sensitivity.

# AdvanFitting-300™

## Interactive system for fitting rooms

### Product codes for ordering

ADFT	-	SS	O	HV	-	FF	-	mmm	
									<b>SS = Screen size</b>
		16							16 inch
									<b>O = Options</b>
			t						touch screen
									<b>HV = Screen orientation</b>
				h					horizontal (landscape)
				v					vertical (portrait)
									<b>FF = Frequency Band</b>
						EU			865,6 MHz - 867,6 MHz
						US			902,0 MHz - 928,0 Mhz
						CH			920,5 Mhz – 924,5 Mhz
									<b>Model</b>
								300	Model number

Example:

- **ADFT-16th-EU-300:**
  - AdvanFitting
  - **16"**
  - **Touch** screen
  - **Horizontal** (landscape) orientation
  - Frequency band: 865,6 MHz - 867,6 MHz
  - Model **300**

