



Newland

SCANNING MADE SIMPLE



PT30 Omura mobile computer user guide

Disclaimer

© 2012-2017 Fujian Newland Auto-ID Tech. Co., Ltd. All rights reserved.

Please read through the manual carefully before using the product and operate it according to the manual. It is advised that you should keep this manual for future reference.

Do not disassemble the device or remove the seal label from the device, doing so will void the product warranty provided by Fujian Newland Auto-ID Tech. Co., Ltd.

All pictures in this manual are for reference only and actual product may differ. Regarding to the product modification and update, Fujian Newland Auto-ID Tech. Co., Ltd. reserves the right to make changes to any software or hardware to improve reliability, function, or design at any time without notice. The information contained herein is subject to change without prior notice.

The products depicted in this manual may include software copyrighted by Fujian Newland Auto-ID Tech. Co., Ltd or third party. The user, corporation or individual, shall not duplicate, in whole or in part, distribute, modify, decompile, disassemble, decode, reverse engineer, rent, transfer or sublicense such software without prior written consent from the copyright holders.

This manual is copyrighted. No part of this publication may be reproduced, distributed or used in any form without written permission from Newland.

Fujian Newland Auto-ID Tech. Co., Ltd. reserves the right to make final interpretation of the statement above.

Fujian Newland Auto-ID Tech. Co., Ltd.

3F, Building A, No.1, Rujiang West Rd., Mawei, Fuzhou, Fujian, China 350015

<http://www.newlandaidc.com>

Revision History

Changes to the original manual are listed below:

Version	Description	Date
V1.0	Initial release.	2012-04-12
V1.1	Corrected improper descriptions.	2012-05-16
V1.2	Updated the figures in Chapter 6.	2012-09-24
V1.3	Updated the screenshots of the PT30.	2014-07-04
V1.4	Updated the screenshots in the “Scan Engine Parameters Configuration” section of Chapter 3 and added the Admin Settings feature in the same chapter.	2016-10-26
V1.5	Modified Chapter 3 and Chapter 5.	2017-05-27
V1.6	1. Modified the “Scanner Settings” section and added the “Redefining Keyboard” section in Chapter 3. 2. Modified Chapter 5.	2017-11-02

Table of Contents

Chapter 1 About This Guide	1
Introduction	1
Documentation Set	1
Software Version	2
Chapter Descriptions	3
More Information	3
Chapter 2 Getting Started	4
Introduction	4
Unpacking	4
Accessories	4
Getting Started	4
Installing the Main Battery	4
Charging the Battery	5
Keypad	5
Power On, Suspend, Wake Up and Power Off	6
Calibrating the Screen	6
Checking Battery Status	7
Installing MicroSD Card	8
Installing SIM Card	9
Adjusting the Hand Strap	9
Chapter 3 Using the PT30 Series	10
Introduction	10
Status Icons	10
Programs Icons	11
Settings Icons	13
Keypad	15
Alphabetic Keypad	16
Function Keys	16
Stylus	16
Volume Control	17
Peripheral Module Power control	17
Backlight Settings	18
Memory Storage Management	18
Resetting the PT30	19

Warm Reset	19
Cold Reset	19
Locking the PT30.....	20
Scanner Settings	21
Normal Settings.....	21
Symbologies.....	25
Test.....	26
Reading 1D Barcode	27
Reading 2D Barcode	28
Admin Settings.....	29
Redefining Keyboard	30
Chapter 4 Using Bluetooth Communication	32
Bluetooth Config	32
Bluetooth Manager	33
Chapter 5 Using WiFi Communication	35
Connecting to a WiFi Network	35
WiFi Tool.....	37
Viewing WiFi Connection Details.....	37
Viewing WiFi Connection Status.....	38
Setting WiFi Parameters	38
Diagnosing WiFi Connection Problems	39
Chapter 6 Using GPRS Communication.....	40
Making New Connection.....	40
Setting Up a Dial-Up Connection.....	42
Checking GPRS Connection Status.....	43
Chapter 7 ActiveSync.....	44
Introduction	44
Installing ActiveSync on PC	44
Synchronizing Data.....	44
Chapter 8 Accessories	45
Battery	45
Cradle	45
Inserting the PT30 into Cradle.....	45
Removing the PT30 from Cradle.....	45
Charging the Battery.....	45

Charging with Cradle.....	45
Charging with AC Adaptor	46
Charging LED	46
Scanning/Decoding/Communication LED.....	46
Communicating with PC Directly.....	46
Communicating with PC via Cradle	47
Chapter 9 Maintenance & Troubleshooting.....	48
Introduction	48
Important Safety & Handling Information	48
Disassembly and Retrofit	48
External Power Supply	48
Abnormal Situation	48
Drop Damage	48
LCD Screen.....	48
Stacking Heavy Objects	48
Mounting Location.....	48
Wireless Functionalities.....	49
Use & Maintenance	49
Battery Safety Guidelines.....	49
Troubleshooting	50

Chapter 1 About This Guide

Introduction

This guide provides information about using the NLS-PT30 series mobile computer (hereinafter referred to as “**the terminal**” or “**the PT30**”) and accessories.

Documentation Set

The documentation set for the NLS-PT30 provides information for specific user needs and includes:

- ✧ ***NLS-PT30 Series Quick Start Guide*** : Describes how to get the NLS-PT30 Series up and running.
- ✧ ***NLS-PT30 Series User Guide*** : Describes how to use the NLS-PT30 Series.

Software Version



The program  can be used to view the terminal's software and hardware version information which is helpful for future updates and maintenance.

The user can obtain the following device information:

- A. System hardware & software version and build time.
- B. The version of WiFi module, and MAC addresses of WiFi and Bluetooth.
- C. The type and version of scan engine.
- D. Version of utility software.



Tap "Start" → "Settings" → "Control Panel" → double click .

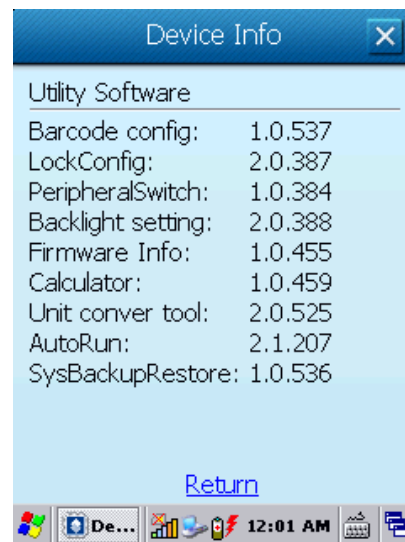
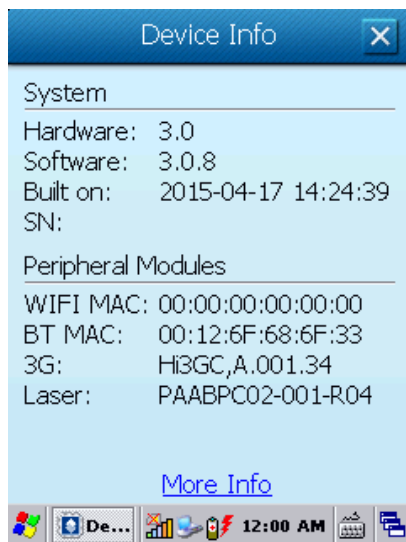

Figure 1.1: Device Information

Chapter Descriptions

- ✧ Chapter 1 About This Guide : Gives a general description of this manual.
- ✧ Chapter 2 Getting Started : Provides information on getting the PT30 up and running for the first time.
- ✧ Chapter 3 Using the PT30 Series : Provides basic instructions for using the PT30.
- ✧ Chapter 4 Using Bluetooth Communication : Explains how to use Bluetooth functionality.
- ✧ Chapter 5 Using WiFi Communication : Explains how to use WiFi functionality.
- ✧ Chapter 6 Using GPRS Communication : Explains how to use GPRS functionality.
- ✧ Chapter 7 ActiveSync : Explains how to synchronize content between the PT30 and the host.
- ✧ Chapter 8, Accessories : Describes the available accessories and how to use them with the PT30.
- ✧ Chapter 9, Maintenance & Troubleshooting : Provides troubleshooting solutions for issues that might occur when using the PT30.

More Information

For more product and support information, please visit our web site: <http://www.newlandaidc.com>.

Chapter 2 Getting Started

Introduction

This chapter lists the parts and accessories for the PT30 Series and explains how to install, remove and charge the batteries, and get the PT30 up and running.

Unpacking

Carefully remove all protective material from the pack.

Verify that you received the following:

- ✧ PT30 Mobile Computer
- ✧ USB cable
- ✧ AC adapter
- ✧ Li-Polymer battery
- ✧ Tethered stylus
- ✧ Hand strap
- ✧ Quick Start Guide

Accessories

- ✧ PT30 single slot cradle
- ✧ PT30 cradle AC adaptor
- ✧ USB cable

Getting Started

Installing the Main Battery

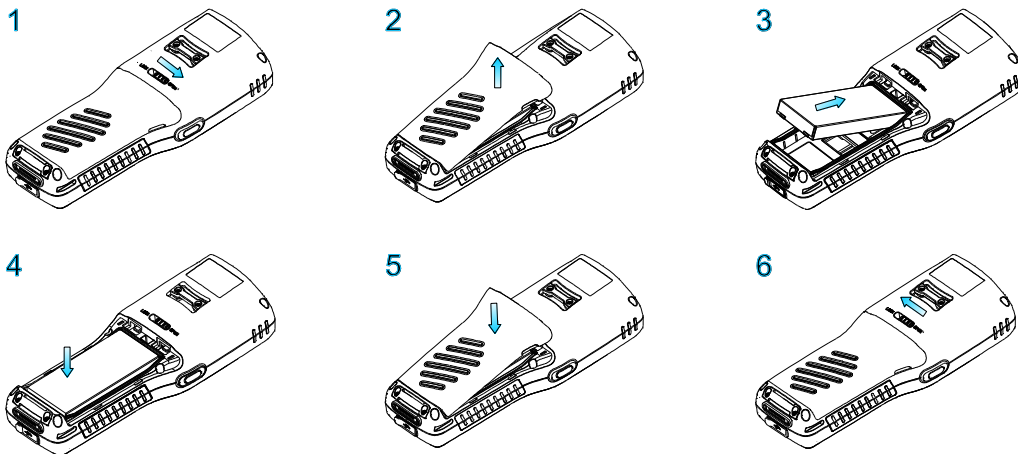

1. Figure 1 indicates the direction to unlock the latch.
2. Figure 2 indicates the direction to take out the battery cover.
3. Follow the instructions of figure 3 and 4 to insert the battery.
4. Follow the instructions of figure 5 to close the battery cover.
5. Push the latch to the locked position.

Charging the Battery

There are two ways to charge the battery:

- ✧ Charge the terminal via USB connection to PC. Charging time: 6-8 hours.
- ✧ Charge the terminal via AC adapter. Charging time: around 3.5 hours.
- ✧ Charge the terminal for at least 8 hours before first use.

LED indication: red LED: charging in progress; green LED: fully charged.

Keypad

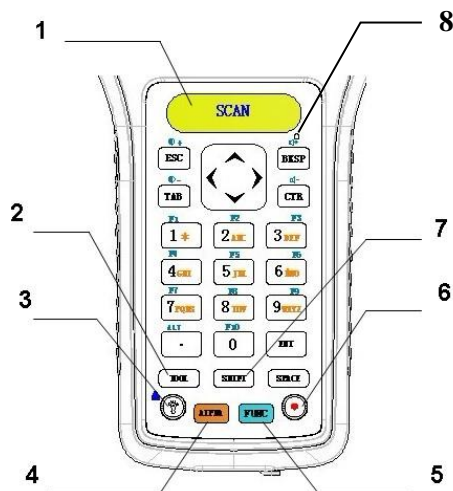

1	SCAN key	Barcode reading button.
2	TOOL key	Pop up the keyboard shortcuts menu (default), or execute the Admin Setting application (when "Sys Shortcut Tools" is turned OFF).
3	Backlight key	Turn screen backlight on or off *Press it down for 7.5s for a warm reset.
4	ALPHA key	Switch between alpha and numeric input.
5	FUNC key	Customize function keys.
6	Power key	Power on/ suspend/ awaken the terminal.
7	SHIFT key	Switch between upper and lower case alphabet entry.
8	Reset key	Warm reset: Insert a straightened paper clip into the hole and press the Reset key in. Cold reset: Hold down the Reset and Power keys.

Power On, Suspend, Wake Up and Power Off

❖ Power On:

Press and hold the Power key for 2-3 seconds to turn the terminal on.

❖ Suspend:

When the terminal is on, holding down the Power key for 2 seconds will suspend the terminal.

If no operation is performed on the terminal for some time, it will go into the suspend mode (in the case that auto suspend is already enabled).

To set the timer for auto suspend, go to “Start”→“Settings”→“Control Panel”→  →“Schemes”.

❖ Wake Up:

When the terminal in the suspend mode, press the Power key to wake it up.

❖ Power Off:

Tap “Start”→“Shutdown”→“Shutdown” to turn off the terminal. The terminal will backup user data before it shuts down.

Calibrating the Screen

The calibration tool is for calibrating the touch screen.

Tap “Start”→“Settings”→“Control Panel”→ double-tap  → tap “Calibration”.

Click “Recalibrate” button then the screen becomes as shown in Figure 2.2. Carefully press and briefly hold the tip of stylus on the center of each target that appears on the screen. Repeat as the target moves around the screen, then tap the screen to continue.



Figure 2.1: Calibration

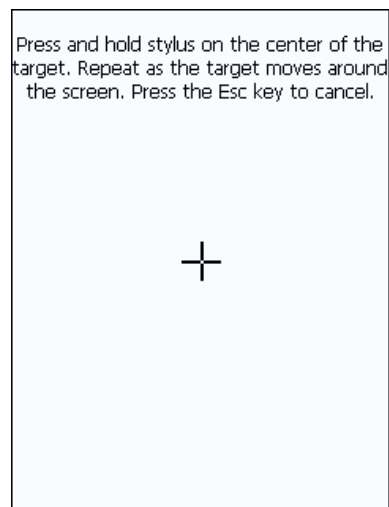

Figure 2.2: Recalibrate

Checking Battery Status

To check the battery status, tap “Start”→“Settings”→“Control Panel”→double click

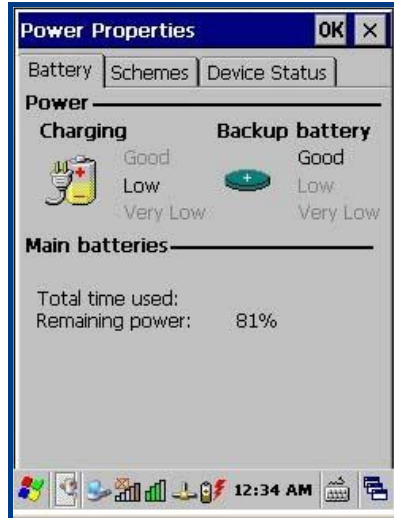

Figure 2.3: Power Properties - Battery



Figure 2.4: Power Properties - Schemes

The system has four states: running, user idle, system idle and suspend:

- ❖ When user operates on the keypad or taps the touch screen, the system is in the running state.
- ❖ After a preset period of inactivity, the system enters the user idle state.
- ❖ After being in the user idle state for a preset period of time, the system enters the system idle state.
- ❖ After being in the system idle state for a preset period of time, the system enters the suspend state.

Installing MicroSD Card

The terminal provides a MicroSD card slot for external storage. The slot is beneath the battery compartment. Follow the instructions of the card manufacturer to use the card.

Insert the MicroSD card into the card slot, with its metal contacts facing down, as shown below.

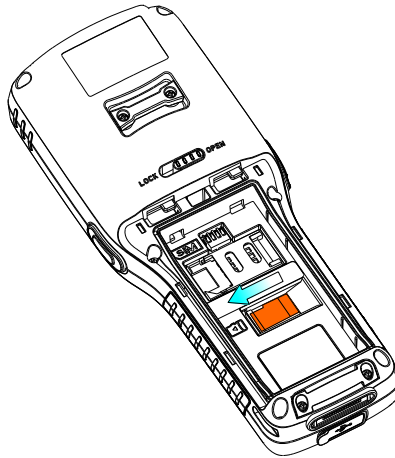

Note that the MicroSD card may not function in any of the following conditions:

1. MicroSD card: It is infected with virus, damaged, or not formatted properly, or its metal contacts are dirty.
2. Card slot: It is squeezed or damaged, or its metal contacts are rusted or bent excessively.
3. Battery: The battery voltage is unstable.

Installing SIM Card

The SIM card slot is beneath the battery compartment and it is available only to the PT30 with GPRS model.

1. Take out the battery. Push the cover release latch in the direction indicated in figure 1 to release the slot cover and open the cover.
2. Insert the SIM card into the slot, with its metal contacts facing down.
3. Push the latch to lock the slot cover in place.

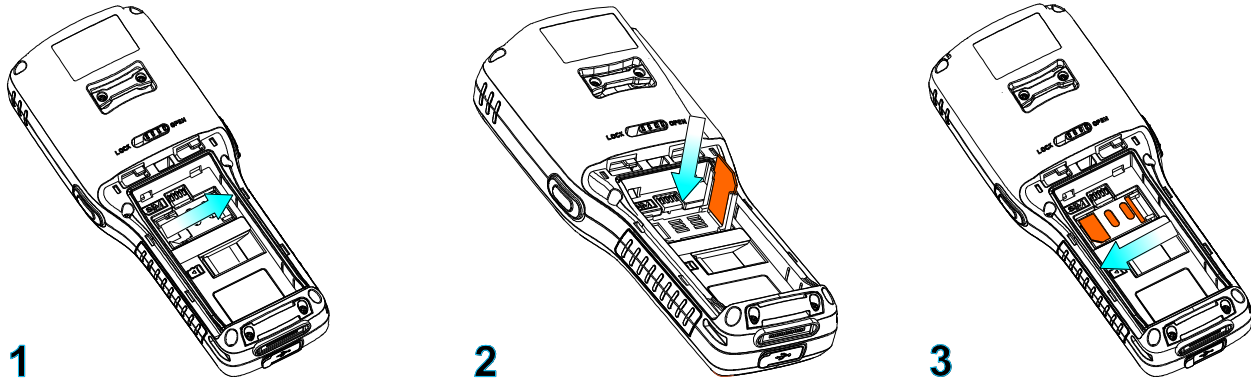

Adjusting the Hand Strap

A hand strap can be attached to the terminal. Adjust the hand strap to increase comfort when holding the terminal for extended periods of time.

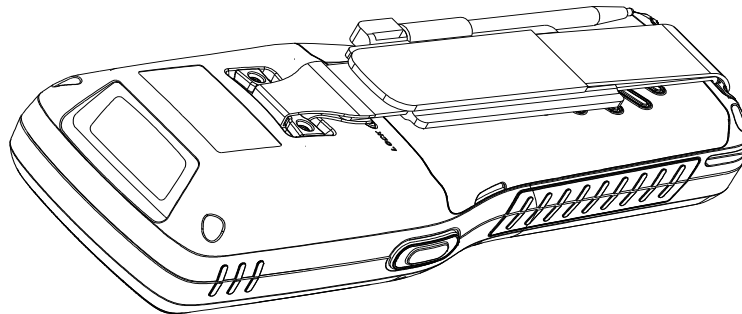

Chapter 3 Using the PT30 Series

Introduction







This chapter provides the detailed instructions for using and setting the PT30.









Figure 3.1: Desktop Icons





Status Icons

The status bar at the bottom of the screen can contain the following status icons.

Icon	Description
	Bluetooth management tool.
	Lowercase input. Press the ALPHA key to toggle between numeric and alphabetic (lowercase) keypad.
	Uppercase input. Press the SHIFT key to toggle between uppercase and lowercase.
	Caps Lock. When alphabetic keypad is enabled, double press the SHIFT key to turn Caps Lock on.
	FUNC key.
	IP information.







	USB connection status.
	Battery status.
	WiFi not connected.
	WiFi connected.
	Clock.
	Soft input panel.
	Background running program selection window.







Programs Icons

Icon	Program Name	Description
 Stylus	Stylus	Touch screen calibration tool.
 Light Setting	Light Setting	Screen and keyboard backlight setting tool.
 Peripheral Switch	Peripheral Switch	Peripheral module power control.
 Calculator	Calculator	Numeric calculation.
 UnitConver	Unit Converter	Unit conversion tool.

 Microsoft WordPad	Microsoft WordPad	Microsoft WordPad text editing tool.
 LockConfig	LockConfig	Keyboard and touch screen lock/unlock tool.
 WirelessM...	WiFi	WiFi communication management and configuration tool.
 Bluetooth Device ...	Bluetooth Device Properties	Bluetooth communication management and configuration tool.
 Barcode Setting	Barcode Setting	Barcode engine configuration tool.
 Autorun	Autorun	Set the programs and parameters which need to boot automatically at startup.
 SysBackup...	SysBackupRestore	Backup/restore system registry, configuration and data in storage memory.
 Firmware Information	Firmware Information	Check the system firmware information and version.
 Putty	Putty	Telnet terminal emulation tool.
 RegEdit	RegEdit	System registry editing tool.
 uEasyFileCE	uEasyFileCE	Bluetooth file transfer utility.

Settings Icons

Icon	Description
 Volume & Sounds	System volume control.
 Internet Options	Internet options settings.
 PC Connection	Enable/disable connections with host PC.
 Storage Manager	Memory storage management and configuration. (Use it with discretion)
 Power	Power properties (battery, schemes and device status) settings.
 Password	Passwords (power on password and screen saver password) settings.
 Date/Time	System date, time and time zone settings.
 Regional Settings	Region, language and input method settings.
 Dialing	Dialing configuration.

 Remove Programs	Remove programs installed on the terminal.
 Input Panel	Input panel settings.
 Owner	Owner properties settings.
 Network and Dial-up Co...	GPRS connection configuration.
 System	View system information.
 Display	Change your desktop background (wallpaper).
 Certificates	View the certificates installed on the terminal.

Keypad

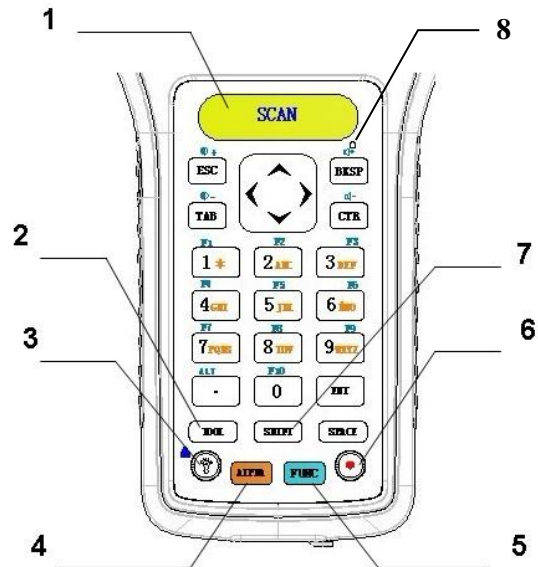



1	SCAN key	Scan barcode key.
2	TOOL key	Pop up the Keyboard Shortcuts menu (default), or open the Admin Setting application (when Sys Shortcut Tools is turned OFF).
3	Backlight key	Turn screen backlight on or off. *Press and hold it for 7.5s for a warm reset.
4	ALPHA key	Toggle between alphabetic and numeric keypad.
5	FUNC key	Customize function keys.
6	Power key	Power on/ suspend/ awaken the terminal.
7	SHIFT key	Switch between uppercase and lowercase mode (effective only when alphabetic keypad is enabled).
8	Reset key	Warm reset: Insert an appropriate pin into the hole and press the Reset key in. Cold reset: Hold down the Reset and Power keys.

Alphabetic Keypad

Numeric Key	ALPHA key locked				ALPHA & SHIFT keys locked			
	1st	2nd	3rd	4th	1st	2nd	3rd	4th
1	*							
2	a	b	c		A	B	C	
3	d	e	f		D	E	F	
4	g	h	i		G	H	I	
5	j	k	l		J	K	L	
6	m	n	o		M	N	O	
7	p	q	r	s	P	Q	R	S
8	t	u	v		T	U	V	
9	w	x	y	Z	W	X	Y	Z

Function Keys

- ✦ FUNC key + Backlight key: Lock/unlock the terminal.
After the FUNC key is pressed, it is locked; it becomes unlocked after another keypress is made.
- ✦ The ALPHA key and FUNC key are independent from each other, so they do not override each other.
- ✦ The SHIFT key works only when the alphabetic keypad is enabled (i.e. the ALPHA key is pressed and locked).
- ✦ When the ALPHA key is pressed and locked, the SHIFT key's intended functions are described as follows:
 - When the SHIFT key is not pressed, the lowercase mode is enabled with the status bar displaying .
 - When the SHIFT key is pressed once, the uppercase mode becomes enabled with the status bar displaying  until any key on the keypad is pressed, be it an alphabetic key or not.
 - When the SHIFT key is pressed twice within an interval of 0.5 seconds, Caps Lock is turned ON with the status bar displaying . To switch to the lowercase mode, simply press the SHIFT key.
- ✦ Long press or double press the TOOL key: Pop up the Keyboard Shortcuts menu (default).
- ✦ TOOL key + a number key (1-9): Run the corresponding program on the Keyboard Shortcut menu.

Stylus

Use the stylus to select items and enter information. The stylus functions as a mouse.

- ✦ Tap : Tap an item on the screen with the stylus to select it.
- ✦ Tap and Hold : Tap and hold an item with the stylus to view a list of actions available for that item.
- ✦ Drag : Hold the stylus on the screen and drag across the screen to select text. Drag multiple items in a list to select them.

CAUTION: To prevent damage to the screen, only use the stylus provided by Newland.

Volume Control

Tap “Start”→“Settings”→“Control Panel”→ double-click  and move the slider to the right or left to raise or lower the volume.

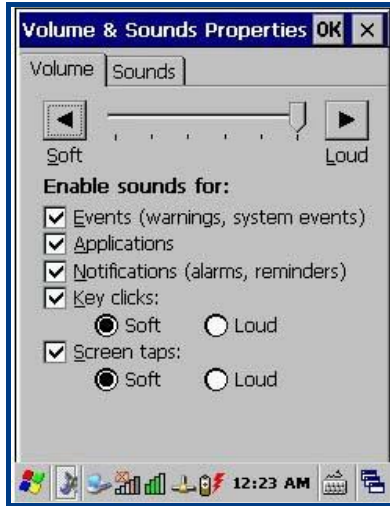



Figure 3.2: Volume



Figure 3.3: Sounds

Peripheral Module Power control

The program  is for users to quickly turn GPRS/3G/Bluetooth/WiFi module on or off.

Tap “Start”→“Settings”→“Control Panel”→double click  to open the program.

Tap “ON” or “OFF” to turn the module on or off. By default, GPRS and WiFi are ON and Bluetooth is OFF.



Figure 3.4: Peripheral Switch

Backlight Settings

Tap “Start”→“Settings”→“Control Panel”→double click  .

❖ Screen Backlight:

- **Normal Mode:**

Normal mode applies when the system is in the running state. There are 11 levels (0-10) of screen brightness for this mode.

- **Low-power Mode:**

Low-power mode allows users to dim the screen to save power if no operation is performed on the screen and keyboard for a preset period of time (switch timer). There are 8 levels (0-7) of screen brightness for this mode. Brightness level for the normal mode must be greater than that for low-power mode.

- **Switch Timer**

Users may set the period of inactivity required to automatically switch from normal mode to low-power mode.

❖ Keyboard Backlight:

Users may set the period of keyboard inactivity required to automatically turn off keyboard backlight.

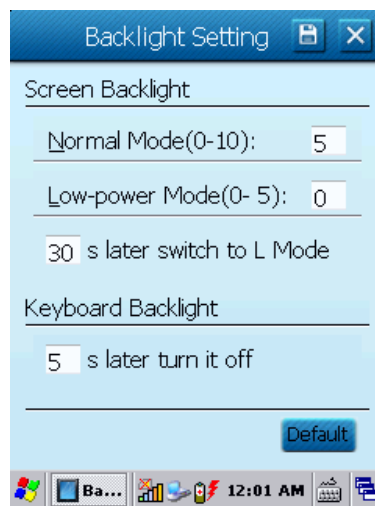



Figure 3.5: Backlight Setting

Memory Storage Management

Caution: When the settings are improperly configured on the memory storage management, system failures may occur. Non-technical staff shall not make any change to it.

The program  is a tool for managing the memory.

- ✧ Format : Format the selected memory, the data in memory will be destroyed after memory is formatted.
- ✧ Dismount : Dismount the selected memory.
- ✧ New Partitions : Create a new partition in selected memory.
- ✧ Delete Partitions : Delete an existing partition in selected memory.



Figure 3.6: Memory Configuration

Resetting the PT30

Warm Reset

Press the Reset button or hold down the Backlight key for 7.5 seconds to perform a warm reset on the terminal. It will take 6-10 seconds to restart the system. User data in memory will not be lost.

Cold Reset

Method 1: Hold down the Power key and then press the Reset button. Do not release the Power key until the terminal displays the loading screen.

Method 2: Press and hold the Power and Backlight keys till the terminal displays the loading screen.

It will take 16-20 seconds for the terminal to reboot. After a cold reset, the terminal will restore factory default settings and user data that is not in MicroSD card or flash disk will be lost. You can use backup/restore tool to restore backup data.

Note: The battery cover must be closed after the Reset button is pressed, otherwise the terminal will immediately enter the suspend mode after restarting.

Locking the PT30

User can lock or unlock the terminal using the program  LockConfig .

Tap “Start”→“Settings”→“Control Panel”→double click  LockConfig to run the program.

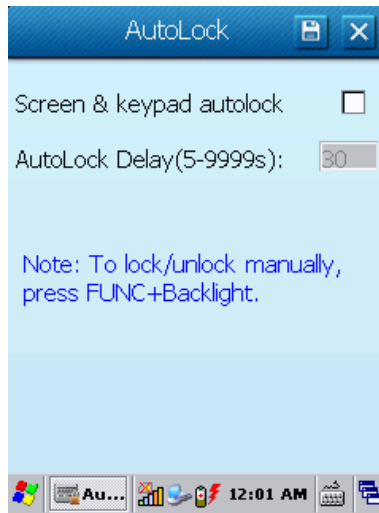

Figure 3.7: Auto Lock

Lock the keyboard and touch screen:

Method 1: If no operation is performed on the PT30 for some time (user programmable), the keyboard and touch screen will be locked automatically.

Method 2: Press the FUNC and Backlight keys simultaneously.

Unlock the keyboard and touch screen:

Method 1: Press the FUNC and Backlight keys simultaneously.

Method 2: Press any key and then tap “Unlock” on the screen.

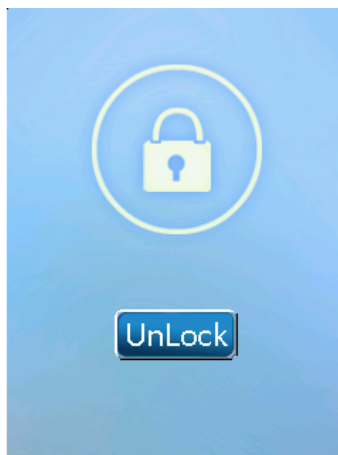

Figure 3.8: Unlock

Scanner Settings

Tap “Start”→“Settings”→“Control Panel”→double tap  . Then the following screen will be displayed.

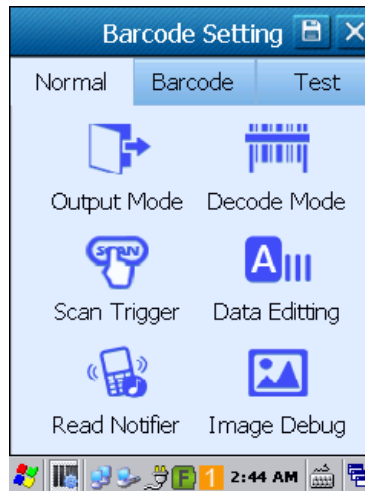

Figure 3.9

Normal Settings

◆ Output Mode

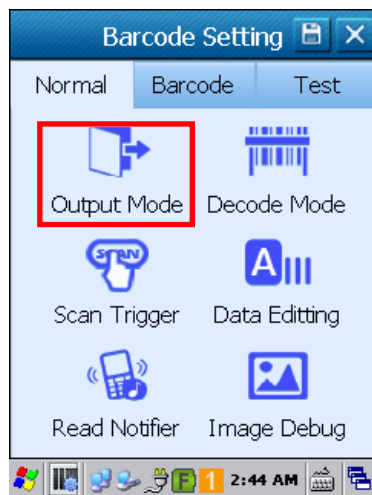

Figure 3.10

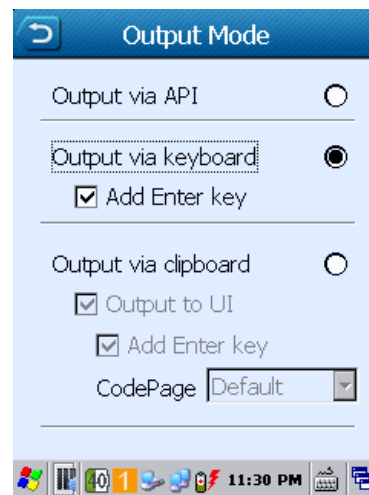

Figure 3.11

The PT30 provides three output modes:

- Output via API : Application uses the API to get the barcode data.
- Output via keyboard : Output the barcode data to keyboard buffer to simulate keyboard input.
- Output via clipboard : Output the barcode data to clipboard.

◆ Decode Mode

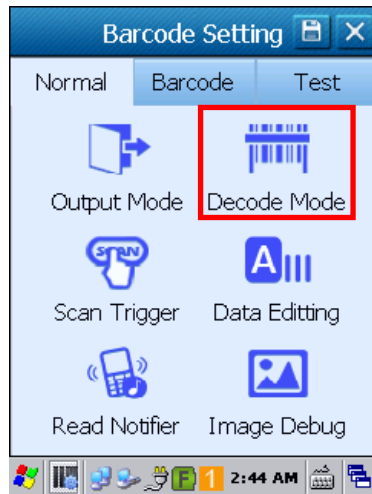

Figure 3.12

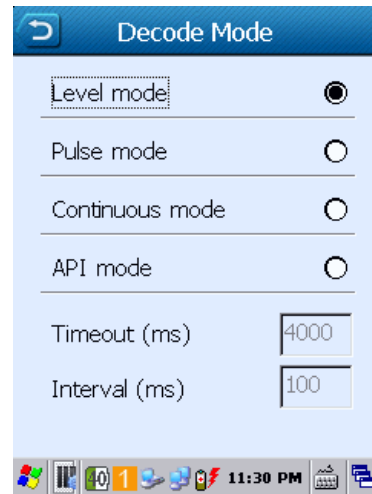

Figure 3.13

● Decode mode

- Level mode: Press the scan trigger to start a decode session which continues until the key is released.
- Pulse mode: Press the scan trigger to start a decode session which continues until a barcode decodes or the decode session timeout expires.
- Continuous mode: Scan barcodes continuously until the scan mode is changed.
- API mode: Start/stop scanning barcode by API software.

● Timeout and Interval:

Timeout sets the maximum time decode session continues during a scan attempt, the default value is 4000ms. Interval sets the time period between decode sessions, the default value is 100ms.

◆ Scan Trigger:

Select a key (SCAN: Scan key; L-SCAN: Left Scan key; R-SCAN: Right Scan key) or key combination as scan trigger by checking the item.

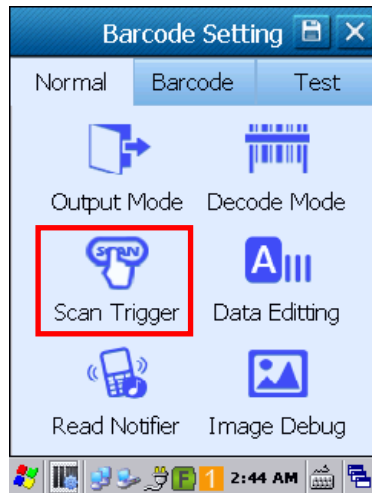

Figure 3.14

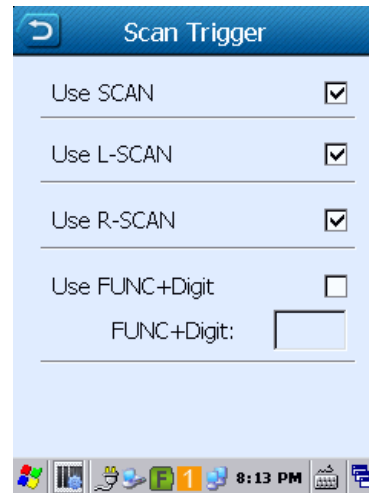

Figure 3.15

◆ Barcode Editing

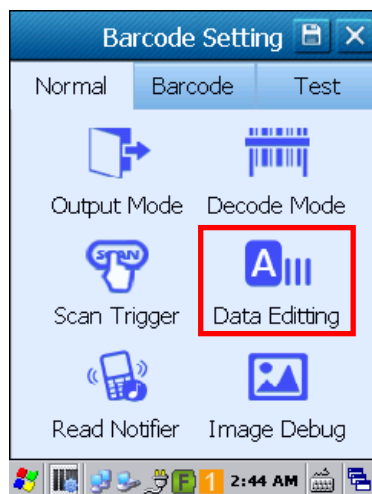

Figure 3.16

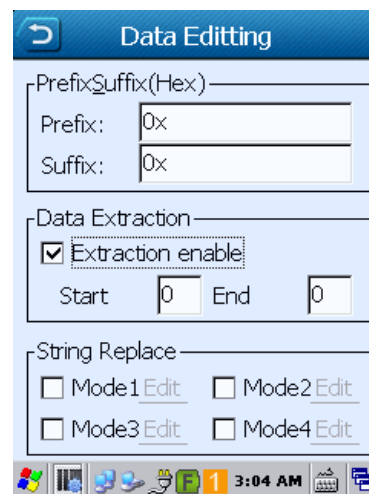

Figure 3.17

● Prefix & Suffix

This feature allows you to append prefix/suffix to raw data. To set the prefix/suffix, enter the hexadecimal value of each character in your desired prefix/suffix. For example, if you want to add "123" before each barcode, set the prefix to "0x313233"; if you want to add a Carriage Return character after each barcode, set the suffix to "0x0D".

- Data Extraction

This feature allows you to output only a selected part of raw data. To enable it, check “Extraction enable”. For example, if you want to output only “DE” in raw data “ABCDE”, enter “3” in the Start field and “4” in the End field.

- String Replace

This feature allows you to replace characters in raw data (up to 4 pairs of character replacements: Mode 1 – Mode 4). To set the replacement string and the string to be replaced, select one of the four modes, tap “Edit”, and then enter the hexadecimal value of each character in the replacement string and the string to be replaced in the corresponding field (e.g. if you want to replace “123” in raw data “12345” with “789”, enter “0x313233” in the String to be replaced field and “0x373839” in the Replacement string field.

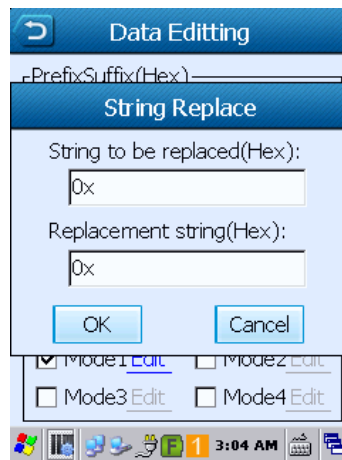

Figure 3.18

◆ Good Read Notifier

Select one or more indicators for good read.

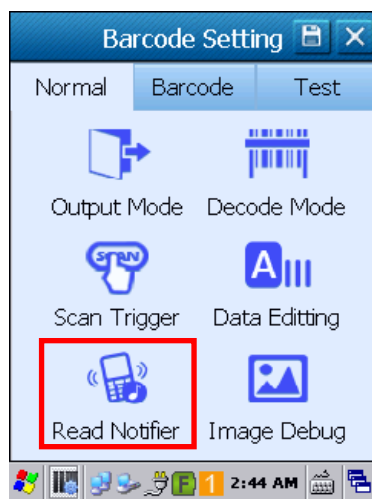

Figure 3.19



Figure 3.20

✦ **Image Debug (Only available on the PT30 equipped with 2D barcode scanner)**

When multiple barcodes are placed closely together, you may specify the decoding area to narrow the scanner's field of view to make sure it reads only those barcodes intended.

To set the decoding area, check "Enable decode valid area" and then set the valid area.

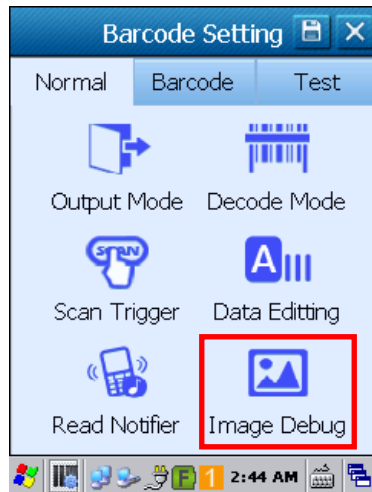

Figure 3.21

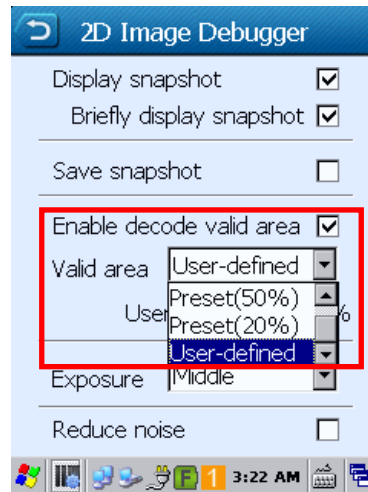

Figure 3.22

Symbologies

Tap the "Barcode" tab on the Barcode Setting screen, then enable/disable the barcode symbologies and set other barcode parameters as per your actual needs.

Supported symbologies may vary by product model.

To disable all 1D or 2D symbologies, select "1D All" or "2D All".

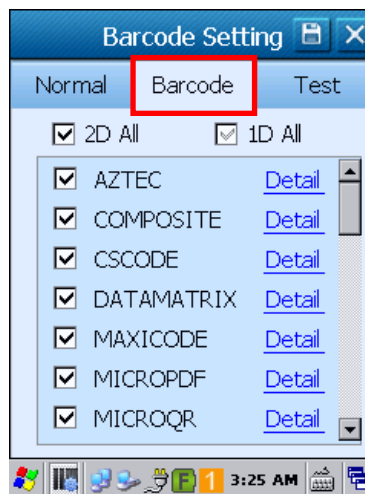

Figure 3.23

Test

You can use this feature to test your terminal's barcode scanning feature. Tap the "Test" tab on the Barcode Setting screen, then scan a barcode with your terminal. Decoded data will appear in the textbox after a good read.

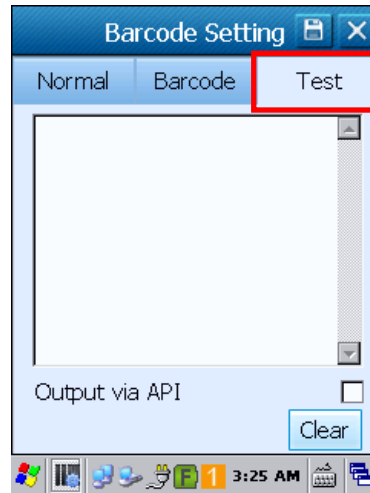
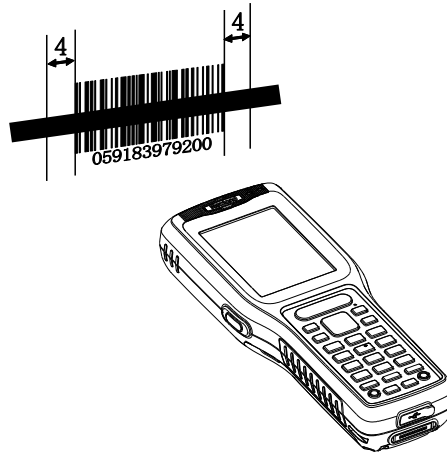

Figure 3.24

Reading 1D Barcode

Adjust the scan angle or the distance between the terminal and the target barcode to ensure the length of laser beam is roughly 8mm greater than that of the barcode, as shown in the following figure.



Right and wrong way of reading:



Reading 2D Barcode

Adjust the scan angle and the distance between the terminal and the target barcode to make them fall into the following ranges:

- A. Point the terminal's focus lamp at the center of the barcode.
- B. Optimum scan distances: 5-20cm.

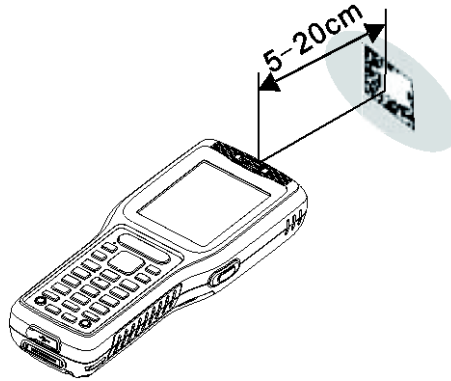

C. Optimum scan angles:

- Pitch (α) < 45° (0° preferably)
- Skew (γ) < 45° (5°- 20° preferably)
- Roll (β) = 0° - 360°

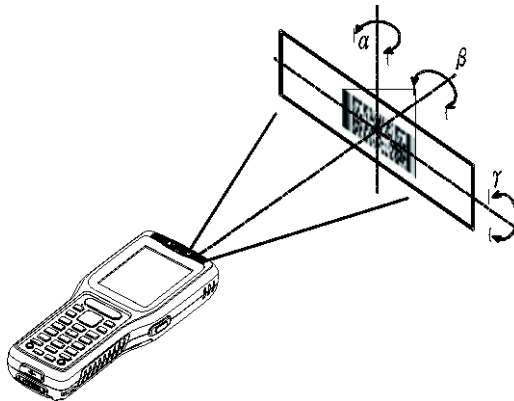

Admin Settings

To run the Admin Setting application, long press or double press the TOOL key on the terminal to open the Keyboard

Shortcuts menu (default), and then double tap . Users will be asked to set the admin password when using it for the first time.

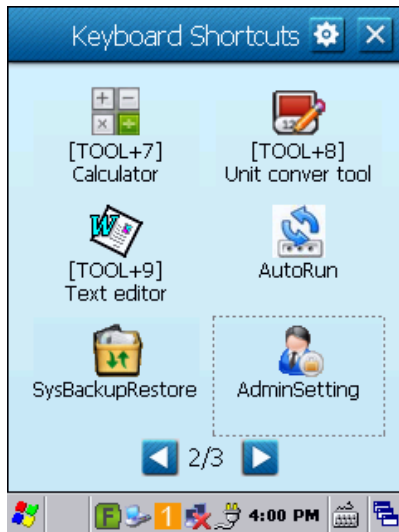

Figure 3.25

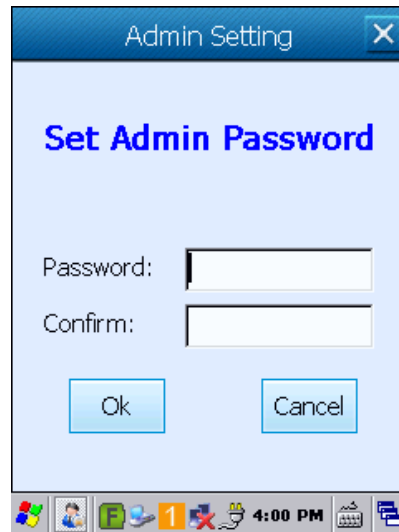

Figure 3.26

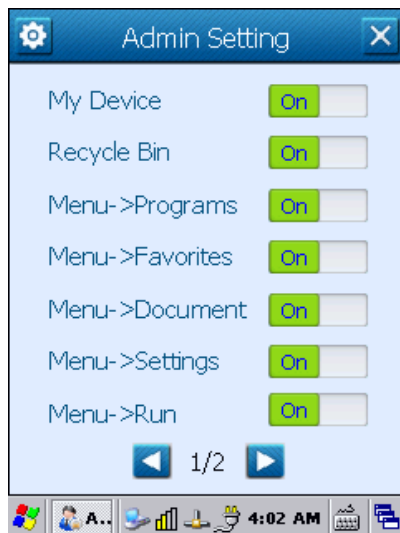

Figure 3.27

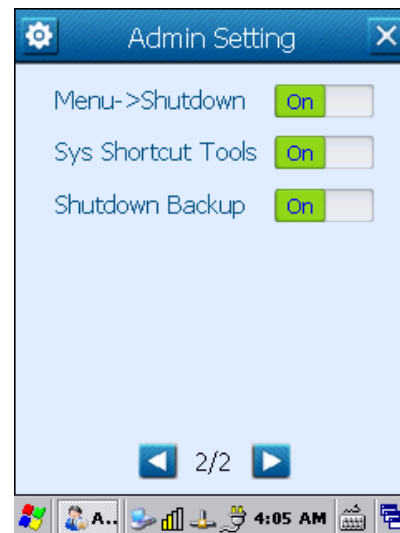

Figure 3.28

My Device/Recycle Bin: Turn it on (default) or off to show or hide the icon on the desktop.

Menu->XX: Turn it on (default) or off to show or hide XX in the Start menu.

Sys Shortcut Tools: When it is On (default), double pressing the TOOL key will open the Keyboard Shortcuts menu; when it is Off, double pressing it will open the Admin Setting application.

Shutdown Backup: Turn it on (default) or off to enable or disable automatic backup during the shutdown process.

Redefining Keyboard

1. Long press or double press the TOOL key on the PT30 to open the Keyboard Shortcuts menu, locate and then double

tap  KeyboardRedefine.

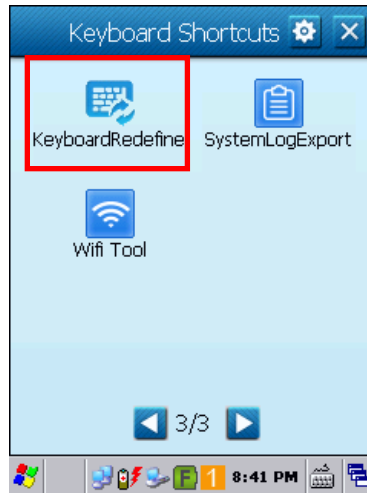



Figure 3.29

2. Tap the “Key Value” field of your desired key then the arrow icon , and select “Redefine keyboard”.

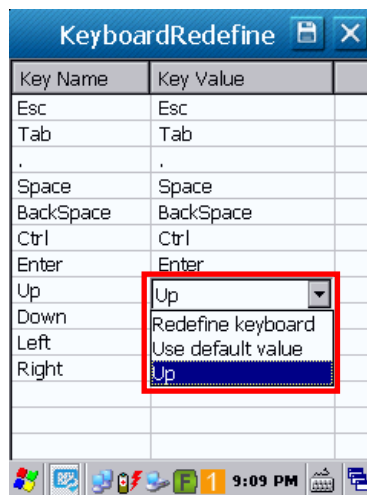

Figure 3.30

3. Select a key value and then tap .



Figure 3.31

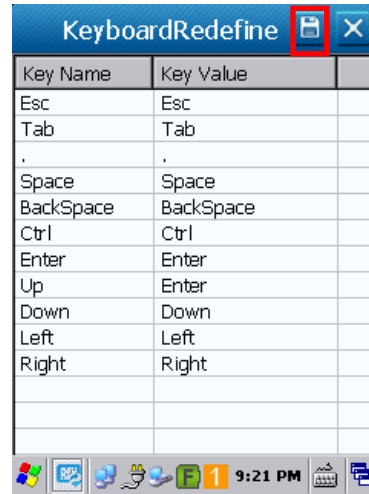

Figure 3.32

Chapter 4 Using Bluetooth Communication

This chapter describes how to connect the PT30 to other Bluetooth device.

Bluetooth Config

Double click  in the status bar, or click this icon and then select “BT Config” to display the BT Configuration window (Figure 4.2).



Figure 4.1: Desktop

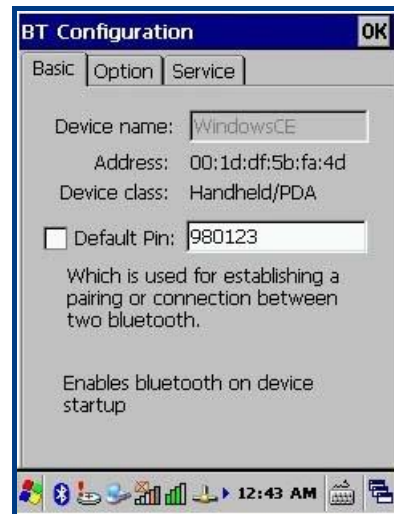

Figure 4.2: BT Configuration (Basic)

- A. Set device name and pin code as per your needs.
- B. Tap the “Option” tab and then select “Discoverable mode”/ “Connectable mode” and “Authentication mode” as per your needs (Figure 4.3).

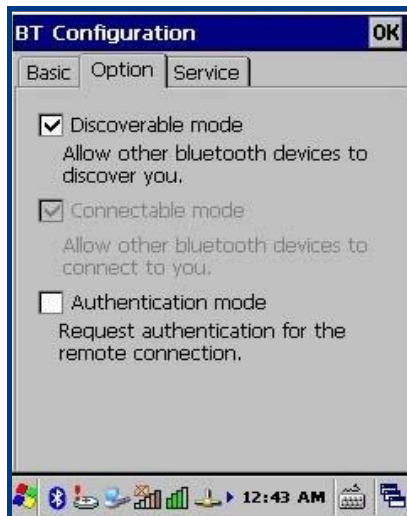

Figure 4.3: Option

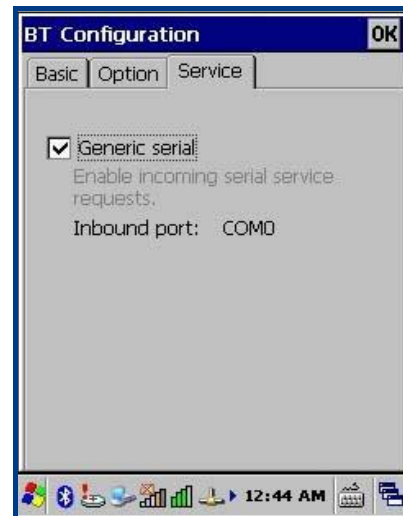

Figure 4.4: Service

- C. Tap the “Service” tab and then select “Generic serial” as per your needs (Figure 4.4).

Bluetooth Manager

Click  in the status bar and then select “BT Manager” to display the BT Manager window (Figure 4.5). You can search for Bluetooth devices and services and pair & connect with a Bluetooth device as per actual needs. For an application program using Bluetooth communication, the terminal will attempt to connect to the most recently connected Bluetooth device automatically if no Bluetooth device is connected to it currently.



Figure 4.5: BT Manager (Pair & Link)



Figure 4.6: Search for Bluetooth Devices



Figure 4.7: Search Services





Figure 4.8: Favorite Connections

Chapter 5 Using WiFi Communication

This chapter describes how to connect the PT30 to a WiFi network, how to view WiFi connection details and status, how to set WiFi parameters, and how to diagnose WiFi connection problems.

Connecting to a WiFi Network

1. Double tap  on the desktop, or tap “Start” → “Settings” → “Control Panel” → double tap , to open the “Peripheral Switch” program. On the “PeripheralSwitch” window, turn WiFi on. Skip this step if it is already turned on.

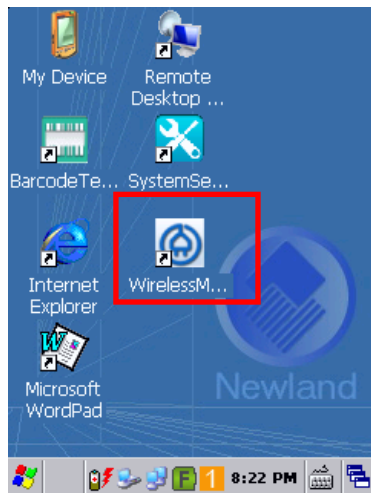

Figure 5.1

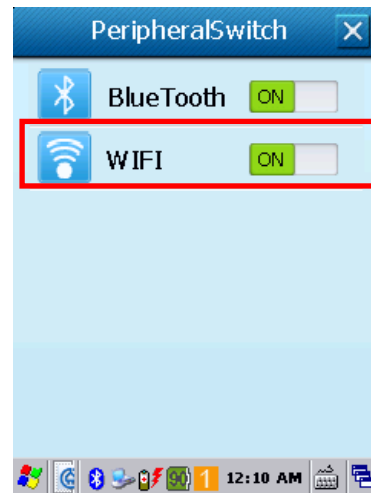



Figure 5.2

2. Double tap  in the status bar.

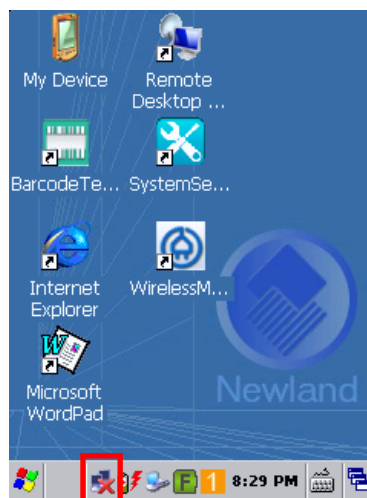



Figure 5.3

3. Tap  then the “Wireless Information” tab. Select a network and tap “Connect”

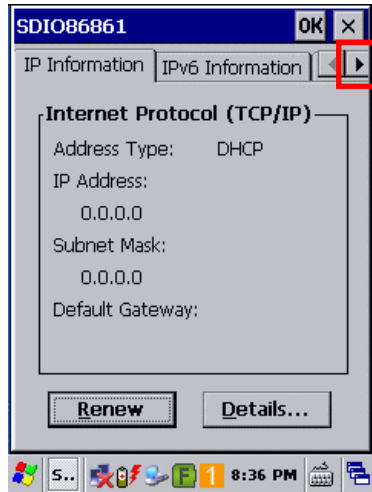

Figure 5.4

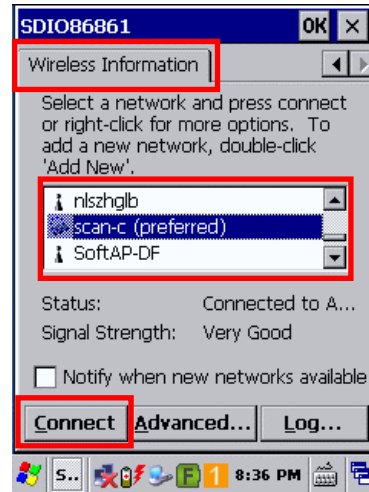

Figure 5.5

4. Manually enter the wireless settings for the network you want to connect to (Network name, Encryption, Authentication and Network key). Then tap “OK”.

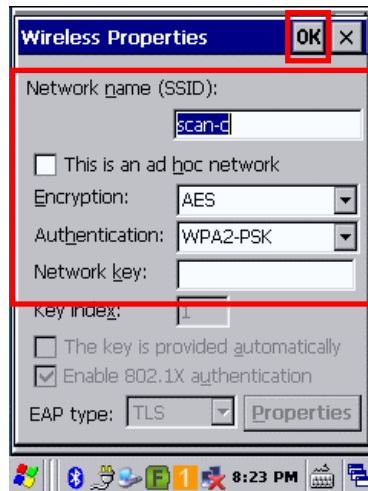



Figure 5.6

WiFi Tool

To start the WiFi tool, long press or double press the TOOL key on the PT30 to open the Keyboard Shortcuts menu, locate

and then double tap  .

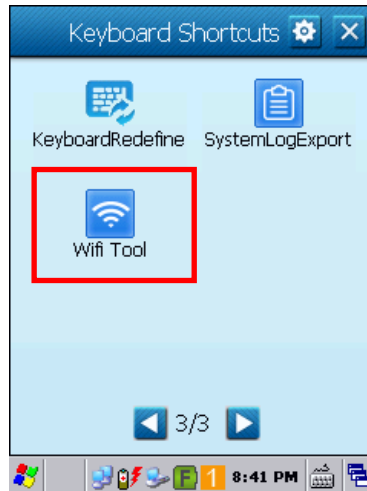
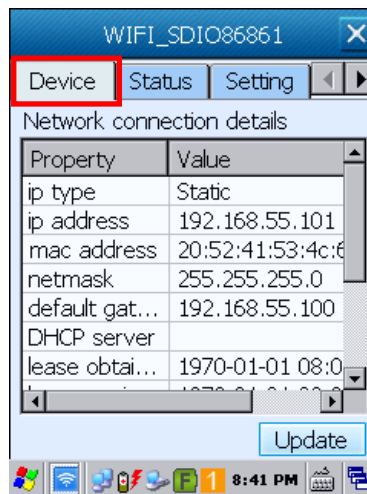

Figure 5.7

Viewing WiFi Connection Details

You can check network connection information such as IP address, MAC address, gateway and DHCP here.



Viewing WiFi Connection Status

You can check the current status of your network connection, SSID, AP MAC address, connection channel and signal strength here.



Setting WiFi Parameters

You can turn WiFi on/off, set the power mode and WiFi protocol, and manage roaming settings here.

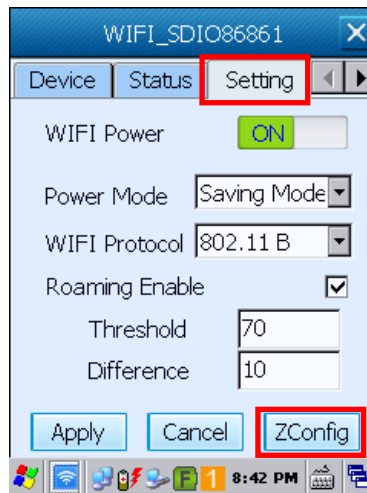

You can also quickly and conveniently open the WiFi Connection Settings screen by tapping "ZConfig".

Diagnosing WiFi Connection Problems

You can test network connectivity with ping and export diagnosis log here.

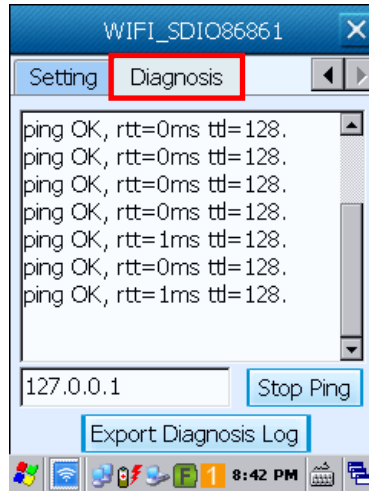

Chapter 6 Using GPRS Communication

Ensure that an activated SIM card, from the phone service provider, is installed in the terminal. By default, a GPRS connection is already created on the PT30. You can tap “Start ”→ “Settings” → “Control Panel” → “Network and Dial-up Connections”, and then double click the GPRS icon to initiate GPRS communication if you are located in China. If you are not located in China, you may either modify the existing GPRS connection or create a new connection by following the instructions below.

Making New Connection

To create a new connection, follow the steps below:

- A. Double click the “Make New Connection” icon (Figure 6.1).
- B. Type “GPRS” or any desired name for the connection and then tap “Next” (Figure 6.2).



Figure 6.1: Make New Connection

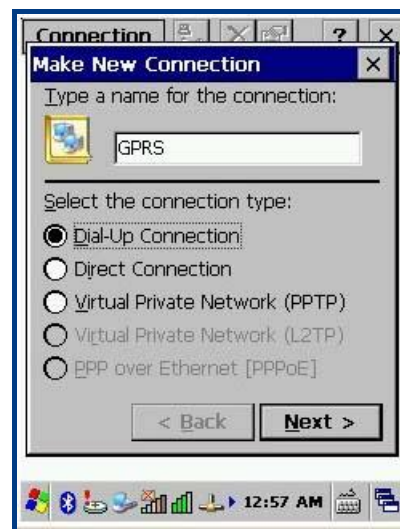

Figure 6.2: Name the connection

- C. Select “Wireless modem Port” in the field of "Select a mode" and tap “Configure...” (Figure 6.3).
- D. Leave the Port Settings at their default values (Figure 6.4).

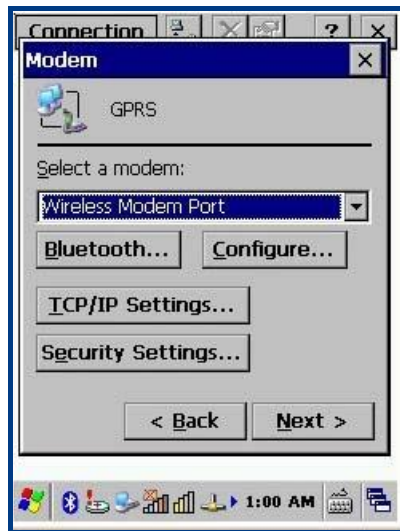

Figure 6.3: Modem

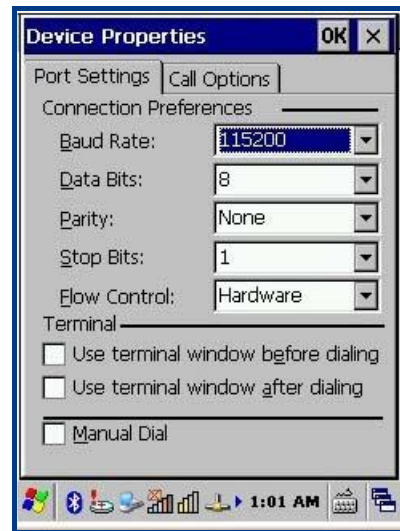

Figure 6.4: Port Settings

- E. Tap the “Call Options” tab. Type **[+cgdcont=1,“IP”,“cmnet”]** in the field at the bottom of the screen. “cmnet” is an example of GPRS APN (access point name). Contact your GPRS service provider to obtain this information. Tap “OK” at the top of the window.

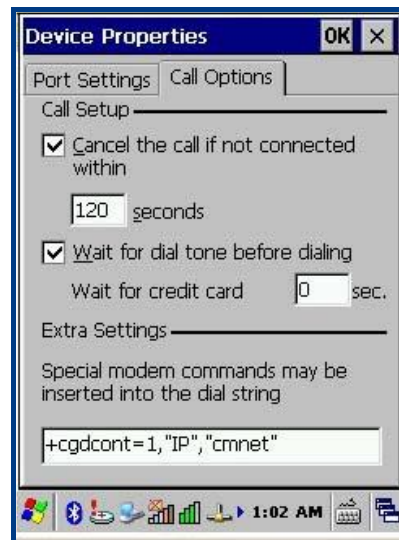

Figure 6.5: Call Options

- F. Enter the phone number in the corresponding field. Tap “Finish” (Figure 6.6).
- G. Then the new connection will appear on the screen. Double click it if you want to initiate GPRS communication.

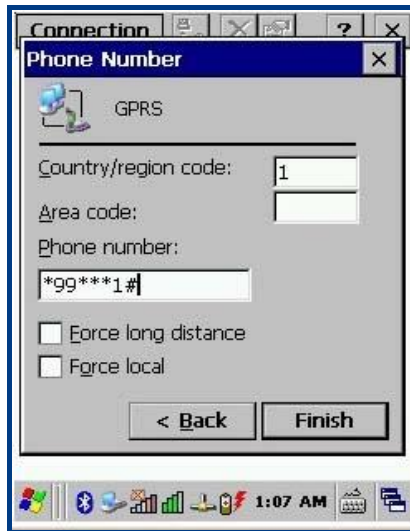

Figure 6.6 Set phone number

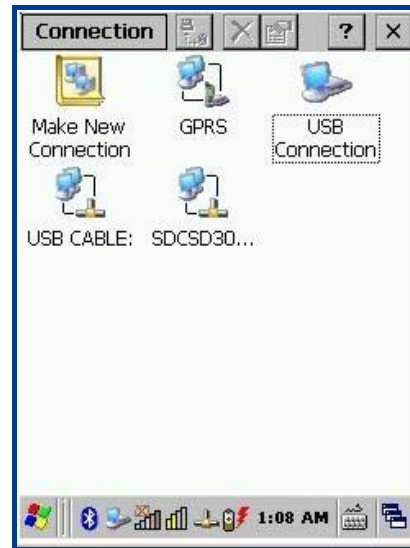

Figure 6.7: New connection created

Setting Up a Dial-Up Connection

To set up a dial-up connection, follow the steps below:

- A. Click "Dial Properties..." in the window as shown in Figure 6.8.
- B. Click "Edit..." in the window as shown in Figure 6.9.



Figure 6.8: Dial-up connection



Figure 6.9: Dialing properties

- C. Enter "G" in the three input fields in the window as shown in Figure 6.10 respectively, and click "OK" at the top of the window. Then click "OK".
- D. Click "Connect" (Figure 6.11).

E. Wait 3-5 seconds for the settings to complete.

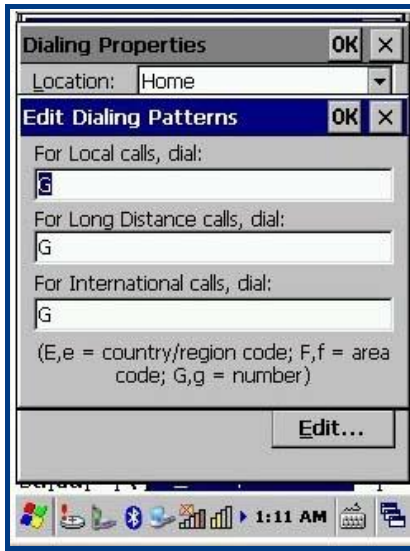

Figure 6.10



Figure 6.11

Checking GPRS Connection Status

Click  in the status bar at the bottom of the screen to view the GPRS connection status.



Figure 6.12: GPRS status

Chapter 7 ActiveSync

Introduction

Microsoft ActiveSync (version 4.5 or higher) is required when you want to synchronize data between the terminal and PC.

Installing ActiveSync on PC

Download ActiveSync (version 4.5 or higher) from the Microsoft web site at <http://www.microsoft.com> and install it on your PC.

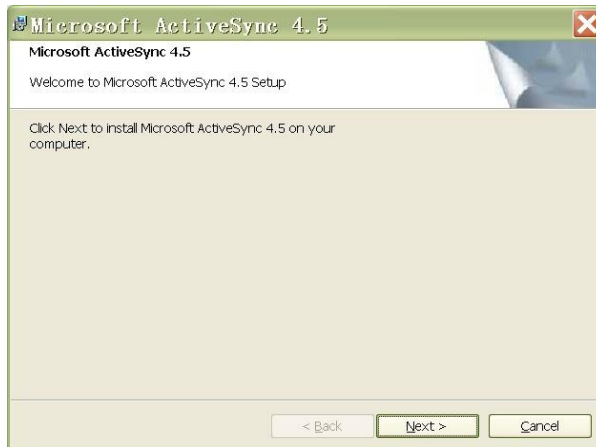

Figure 7.1 ActiveSync Installation interface

Synchronizing Data

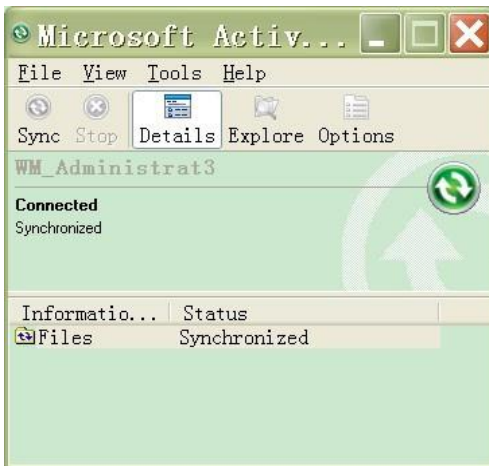

Figure 7.2: Synchronize details



Figure 7.3 Choose item(s) to synchronize

Chapter 8 Accessories

Battery

Low battery may result in misoperation of the terminal. Before your first use, charge the battery for at least 8 hours to ensure both the main and backup batteries are fully charged.

Cradle

Inserting the PT30 into Cradle

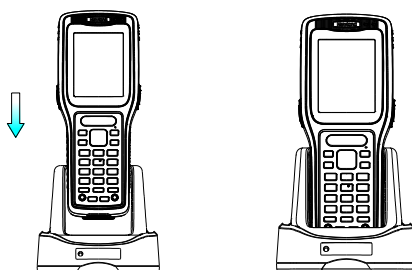

Removing the PT30 from Cradle



Charging the Battery

Charging with Cradle

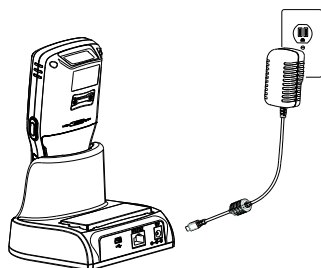

Charging with AC Adaptor



Charging LED

Red LED on: Charging in progress.

Green LED on: Fully charged.

Scanning/Decoding/Communication LED

Red LED on: The terminal is scanning barcode.

Green LED on: A barcode is decoded.

Blue LED flashes: BT/WiFi/GPRS/3G module in the PT30 is communicating.

Communicating with PC Directly

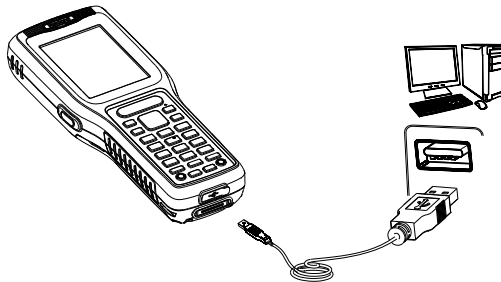

1. Open the USB port cover located at the bottom of the PT30.
2. Plug one end of the USB cable into the USB port on the PT30 and the other end of the cable into PC.

Note: Make sure Microsoft ActiveSync is already installed on the PC before performing data communication between the terminal and the PC.

Communicating with PC via Cradle

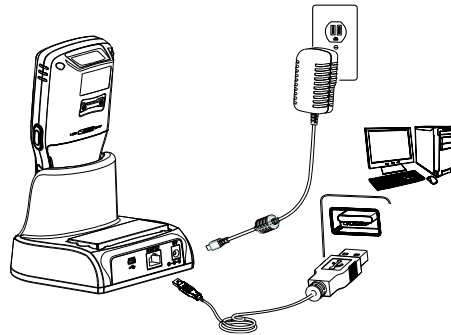

1. Insert the PT30 into the dedicated cradle.
2. Plug one end of the USB cable into the USB port on the cradle and the other end of the cable into PC.

Note: Make sure Microsoft ActiveSync is already installed on the PC before performing data communication between the terminal and the PC.

Chapter 9 Maintenance & Troubleshooting

Introduction

This chapter includes important safety and handling information and provides troubleshooting solutions for issues that might occur when using the terminal.

Important Safety & Handling Information

Disassembly and Retrofit

Do not disassemble or retrofit the terminal by yourself. Artificial damages caused by failure to observe this precaution are not covered by the warranty.

External Power Supply

Use only the supplied AC adapter. Otherwise there is a risk of damage to the terminal.

Abnormal Situation

Keep the terminal away from fire or heat sources. If there is unusual odor, overheating or smoke, immediately cut off the power and disconnect the AC adapter, and contact your dealer or Newland customer service center. Continued use in this case may result in fire or electric shock.

Drop Damage

If the terminal is damaged due to a drop from high place, immediately cut off the power and contact your dealer or Newland customer service center.

LCD Screen

Do not press against or strike the LCD screen. Otherwise it may damage the screen. When handling a cracked or shattered screen, do not touch the liquid that has leaked from it to avoid skin burn or infection.

Stacking Heavy Objects

Do not place heavy objects on the terminal as those objects may fall and cause injury.

Mounting Location

Do not place the terminal on unstable or uneven surfaces as it may fall and cause injury. Do not expose the terminal to humidity, dust or direct sunlight.

Wireless Functionalities

Do not use the terminal's wireless functionalities where wireless device use is prohibited or where it may cause interference or danger, such as in aircrafts, petrol stations.

Use & Maintenance

- ✧ If the terminal cannot be switched on after experiencing a sudden or unexpected power loss or other abnormalities, try performing a warm reset on the terminal by pushing the Reset button with a pin. For the location of the button, please refer to the related chapter.
- ✧ Do not throw, drop or strike the terminal. Doing so may damage the LCD display, interrupt running programs, cause data loss in memory and result in malfunction.
- ✧ Clean the scan window regularly. Do not touch it with hands. Scratched or smudged window may degrade reading performance.
- ✧ Do not tap the touch screen with sharp objects. Doing so may damage the screen or cause internal short circuits.
- ✧ Use only a dry soft cloth to clean the terminal. Cleaning it with wet cloth or benzene/ thinner/ other volatile chemicals may deform and shorten the useful life of the keyboard and shell of the terminal.
- ✧ Do not place the terminal facedown on any surface, or there might be misoperations.
- ✧ Sudden temperature drops may cause condensation on the shell which could cause malfunction. If condensation occurs, dry the terminal before use.

Battery Safety Guidelines

- ✧ Do not dispose of batteries in a fire as they may explode!
- ✧ The battery can be charged and discharged over 500 times. If the battery life is unreasonably short, please replace the battery with a new one.
- ✧ Use only the manufacturer-approved battery and AC adapter.
- ✧ Unplug the AC adapter when it is not in use. Do not continue to charge a battery that is fully charged. Overcharging will shorten battery lifespan. If a fully charged battery is not used, it will discharge slowly, which does not affect its normal use.
- ✧ Do not use damaged or dysfunctional AC adapters and batteries.
- ✧ Properly dispose of and recycle batteries. Do not dispose of them as household garbage.

Troubleshooting

Problem		Possible Cause & Solution
Type	Description	
Keyboard	Keyboard failure or incorrect response to any key entry.	Unreliable cable connection between keyboard and mainboard or keyboard malfunction. Please contact Newland after-sales service.
Battery	Battery indicator is OFF when charging.	Ensure the AC adapter is plugged in and properly connected.
	Noticeably short battery life.	<ol style="list-style-type: none"> 1. Check the battery level. If the battery is almost depleted, recharge it. 2. Replace the battery if it is dysfunctional.
	Fully charged battery is depleted after the terminal is switched on.	Replace the battery.
USB	USB communication failure.	<ol style="list-style-type: none"> 1. Ensure that the USB cable connections are secure. 2. Ensure that there is no contaminant inside the Micro USB port. 3. If the problem still remains, please contact the after-sales service center.
LCD Screen	No display.	<ol style="list-style-type: none"> 1. Ensure the terminal is switched on. 2. If the terminal is in suspend mode, press the Power key to wake it up. 3. Check the battery level. If the battery is almost depleted, recharge it. 4. Ensure that the battery is properly installed. 5. Replace the battery if it is dysfunctional. 6. If the problem still remains, please contact the after-sales service center.
System	Cannot switch on.	<ol style="list-style-type: none"> 1. Check the battery level. If the battery is depleted, recharge it. 2. Switch the terminal on after using the included AC adapter to connect it to a power outlet. If the problem disappears, then continue to charge the terminal. If the problem remains after charging the terminal for a while, replace the battery with a new one.
	System halted.	<ol style="list-style-type: none"> 1. The problem may be caused by downloaded apps. Ensure that only reliable apps are used. 2. The problem may be caused by a sudden or unexpected power loss. Perform a warm reset on the terminal by pushing the Reset button with a pin. 3. If warm reset does not work, try cold reset to reset the terminal to factory default settings.



Newland

SCANNING MADE SIMPLE

Newland EMEA HQ

+31 (0) 345 87 00 33
info@newland-id.com
newland-id.com

D-A-C-H

+49 (6) 182 82916-16
info@newland-id.de

Benelux

+31 (0) 345 87 00 33
benelux@newland-id.com

Italy

+39 (0) 342 0562227
italy@newland-id.com

United Kingdom

+44 (0) 1442 212020
sales@newland-id.co.uk

South Africa

Gauteng: +27 (0) 11 553 8010
Cape Town: +27 (0) 21 9140819
info@newland-id.co.za

Turkey

+90 (0) 544 538 40 49
turkey@newland-id.com

France

+39 (0) 345 8804096
france@newland-id.com

Ibérica

+34 (0) 93 303 74 66
info@newland-id.es

Nordic & Baltic

+46 (0) 70 88 47 767
nordic@newland-id.com

Russia

+31 (0) 345 87 00 33
russia@newland-id.com

Middle East

+39 (0) 345 8804096
middleeast@newland-id.com

Iran

+90 (0) 544 538 40 49
iran@newland-id.com